



SPARTAN™

BODY & LIGHT KIT FOR CLUB CAR DS



Club Car DS - Spartan

TABLE OF CONTENTS:

- Step 1** - Prebuild Car Prep
- Step 2** - Install Wiring Harnesses and Perform Testing
- Step 3** - Install Rear Body
- Step 4** - Install Optional Steering Column Cover & Sentry Dash
- Step 5** - Install Optional Pilot Steering Wheel

IMPORTANT: Do not fully tighten hardware until instructed. Read through all instructions before beginning installation.

WARNING: DO NOT CONNECT THE LIGHT KIT WIRING HARNESS TO MORE THAN 16 VOLTS OR PERMANENT DAMAGE TO HARNESS AND LIGHTS WILL OCCUR.

Do not attempt to service the vehicle while it is moving. Prior to servicing, turn the key switch OFF, remove the key, and place the Forward / Reverse handle in Neutral position. Block all wheels when servicing the vehicle.

Batteries – are explosive! Do not smoke. Keep sparks and flames away from the vehicle and service area. Ventilate when charging or operating vehicle in an enclosed space. Wear a full-face shield and rubber gloves when working on or near batteries.

Make sure all wiring and wire harness are properly routed and secure before any initial testing is done. Position all electrical components in areas that are protected from moisture and or salt air.

ALL ELECTRIC VEHICLES:

To avoid unintentionally starting the vehicle, disconnect the batteries as shown on top right.

ELECTRIC VEHICLES WITH SPEED CONTROLLERS:

After disconnecting the batteries, discharge the controller capacitors as follows:

- Turn key to ON and place the forward / reverse handle in REVERSE.
- Slowly depress accelerator pedal and keep depressed until the reverse warning buzzer can no longer be heard. When buzzer stops sounding, the controller capacitors are discharged.

NOTE: For models with a TOW/RUN switch, place the switch in the TOW POSITION before disconnecting or connecting the battery cables.

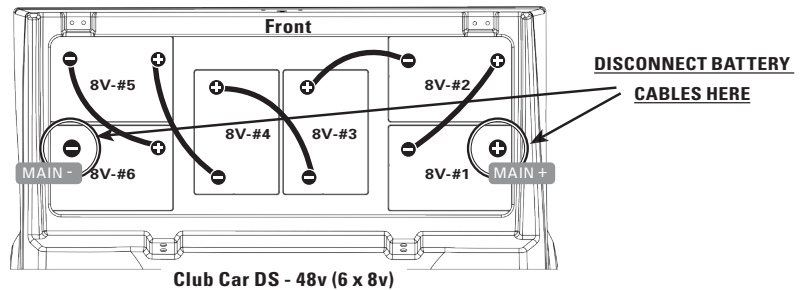

Club Car DS - 48v (6 x 8v)

LIGHT KIT COMPONENTS



DELUXE WIRING HARNESS

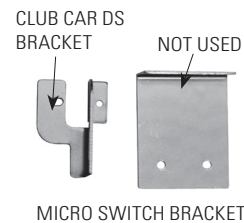

MICRO SWITCH BRACKETS



TURN SIGNAL



STEERING COLUMN COVER



LED HEADLIGHTS & TAIL LIGHTS

PREBUILD CAR PREP

STEP 1 PREPARE CAR FOR INSTALLATION

Remove the following:

- Factory Top
- Front Frame
- Factory Top Rear Supports
- Windshield
- Sweater Basket
- Seat Back Supports
- Front Seat Bottom
- Front and Rear Colored Body Panels
- Side Rocker Panels
- Rear Bumper

INSTALL WIRING HARNESS

STEP 2.1 REMOVE PARTS FROM HARNESS

Remove the following components from Wiring Harness, if attached, and set aside for use later.



ON/OFF SWITCH



MICRO SWITCH

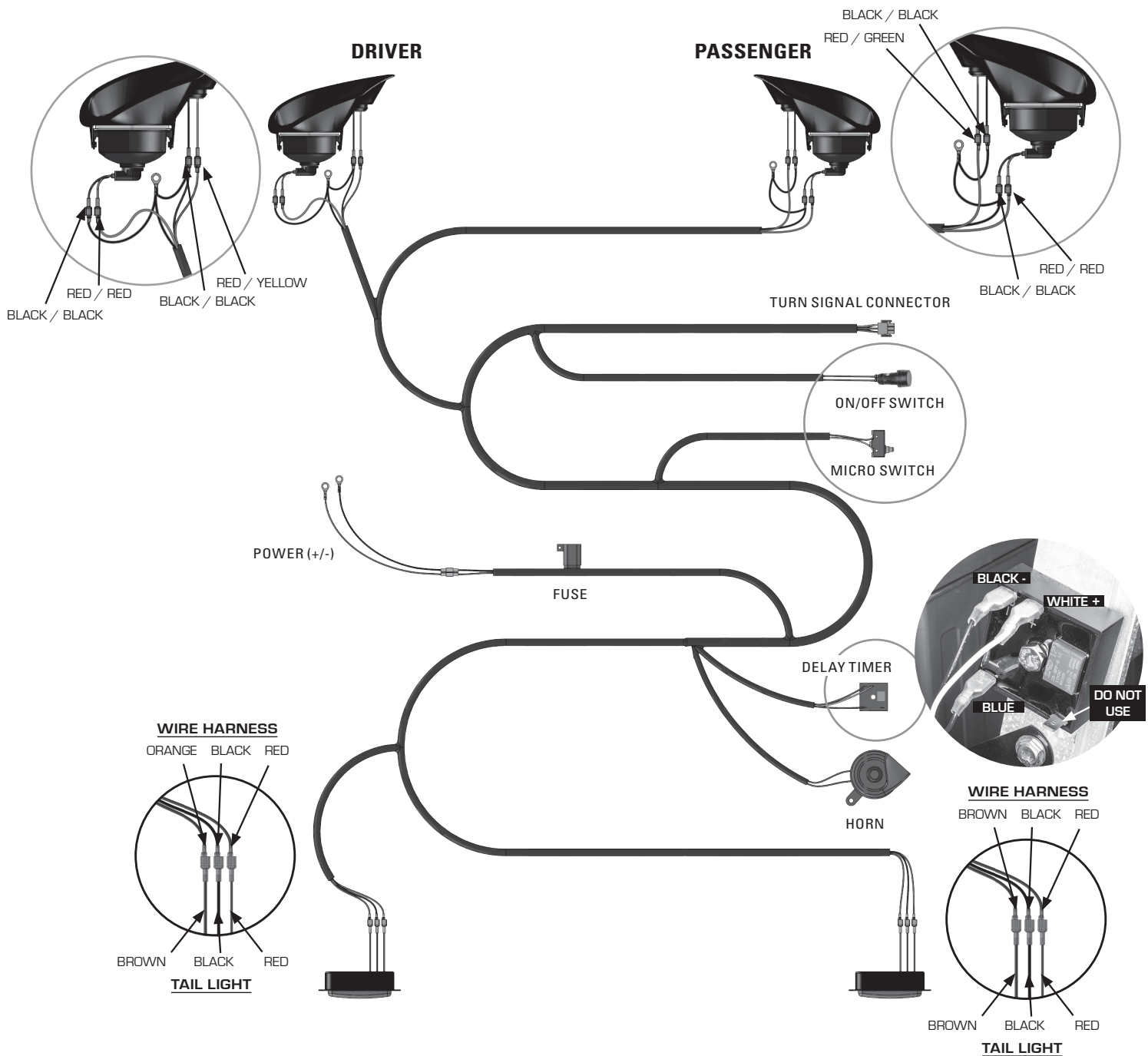

Manufactured By Custom Golf Car Supply, Inc.

& PERFORM TESTING

STEP 2.2 ROUTE HARNESS TO REAR

A. Route the complete Wiring Harness, except for the section with power connection and fuse, down through the batteries and out of the bottom of chassis (1). Route the Smaller Harness section for Tail Lights to the rear of the car (2). Loosely secure Harness with zip-ties until all components have been installed and tested.

B. Route the Tail Light Harness section to rear of car on Driver side. Feed the shortest section under the Frame and secure with Cable Ties (3). Route the Longest section under the aluminum channel across the rear of car to the Passenger side, under the Frame, and secure with Cable Ties (4).

C. Temporarily connect the Tail Lights to the Harness for testing.

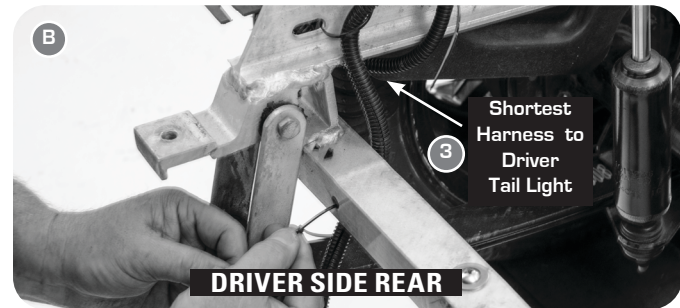
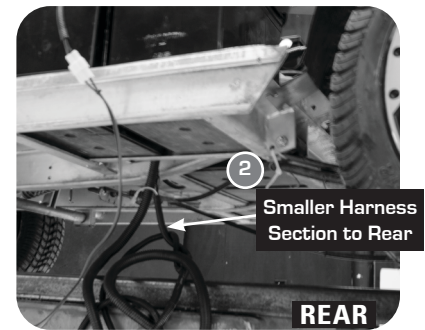
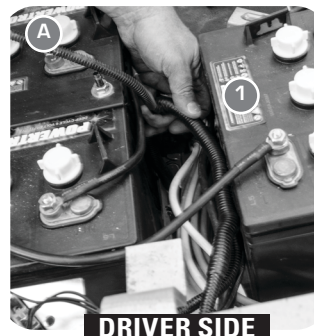

STEP 2.3 ROUTE HARNESS TO FRONT

D. Mount the Micro Switch Bracket (5) to the Micro Switch (6) as shown using Hardware (7) — **Do not overtighten.**

E. Route the Wiring Harness for Headlights under the chassis along the Driver side I-beam and towards the front of the car. Locate the clamp that attaches the Brake Rocker Arm to the Chassis. The Micro Switch Bracket will mount on top of the bolt closest to the rear of car (8).

F. Mount the Micro Switch Bracket on top of the existing bolt and nut. Make sure the Brake Pedal is completely depressed (Parking Brake engaged) and slide the Bracket forward so that the button on the Micro Switch is fully compressed. Secure Bracket with 1/4" Nyloc Nut (8) on the existing bolt.

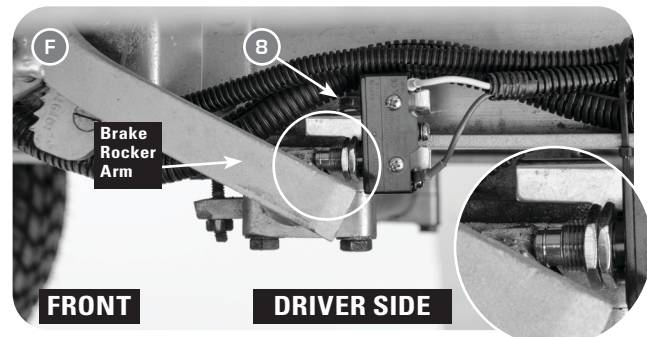
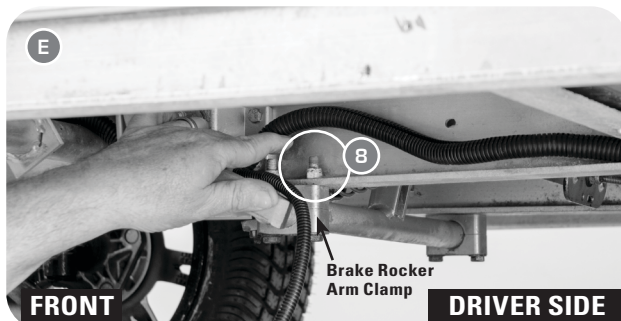
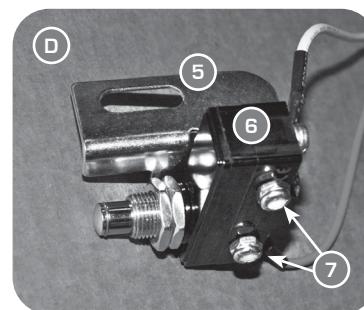

STEP 2.4 ROUTE HEADLIGHT HARNESS TO FRONT AND SECURE

G. Secure the excess Harness to the chassis with Cable-Ties.

H. Route the remaining Harness to the front of the car **(9)** with the shorter Harness to the Driver Headlight **(10)** and Longer Harness to the Passenger Headlight **(11)**. Secure with Cable-Ties.

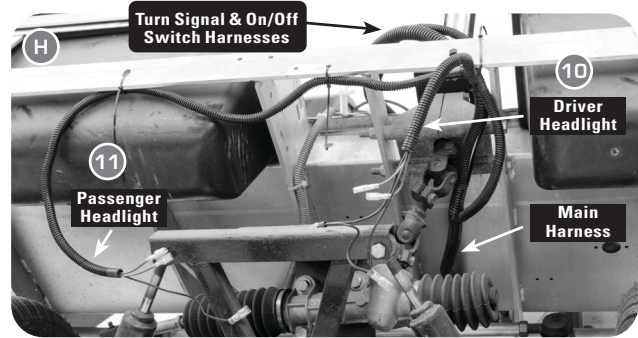
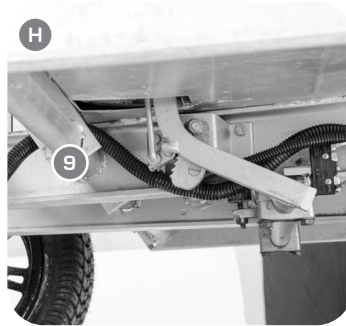
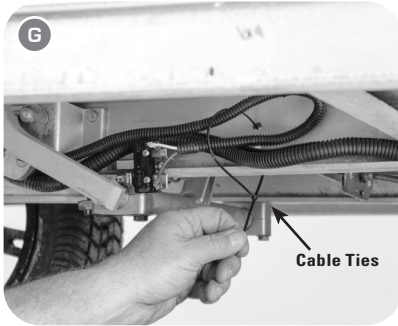

STEP 2.5 MOUNT HORN AND DELAY TIMER

- Mount the Horn Bracket to the Chassis Frame on the Driver side, just above and to the front of the wheel well, using the existing hole **(12)**. Mount the Delay Timer above the Horn Bracket **(13)**.

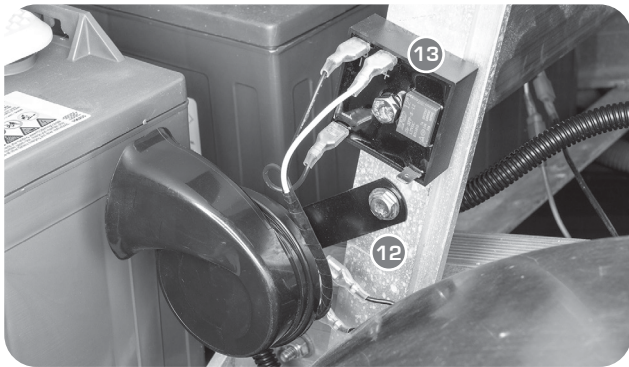

STEP 2.6 INSTALL FRONT BUMPER

- Mount the Bumper **(14)** to the Bumper Extension Bracket **(15)** using the factory hardware. Mount Bumper Extension Bracket to original location **(16)** with provided hardware.

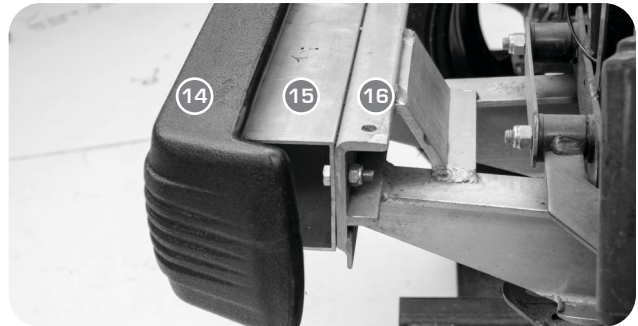

HARDWARE - SCALE 1:1

S

1/4" Nyloc Nut



STEP 2.7 INSTALL FRONT COWL

- Peel back protective film from the top edge of Front Cowl. Make sure Cowl is fully seated against Dash Frame and the top and side edges of Front Cowl are wedged between the Dash Trim **(17)** and reinstall factory hardware on top and sides of Dash Trim **(18)**.

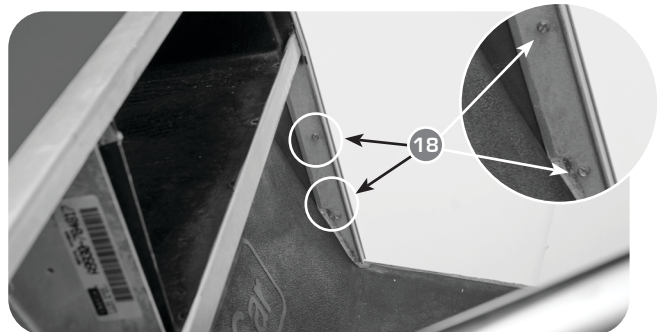
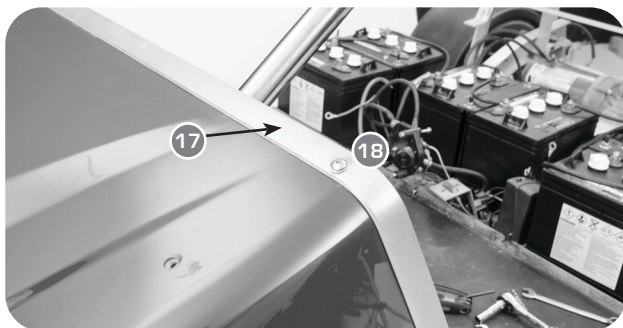

STEP 2.8 CONNECT PARTS FOR TEST

- Temporarily connect the Turn Signal and On/Off Switch for testing. These components will be installed in later steps.

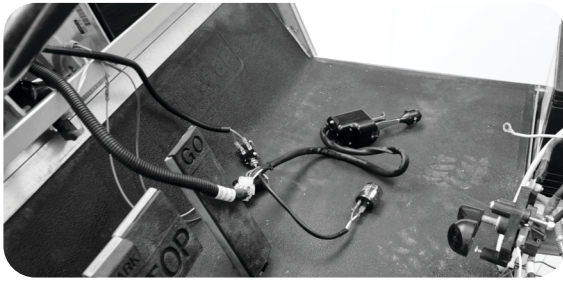

STEP 2.9 CONNECT HEADLIGHTS FOR TEST

- Temporarily connect Headlights for testing, following the connection diagram below. Set the lights in the Front Cowl for testing.

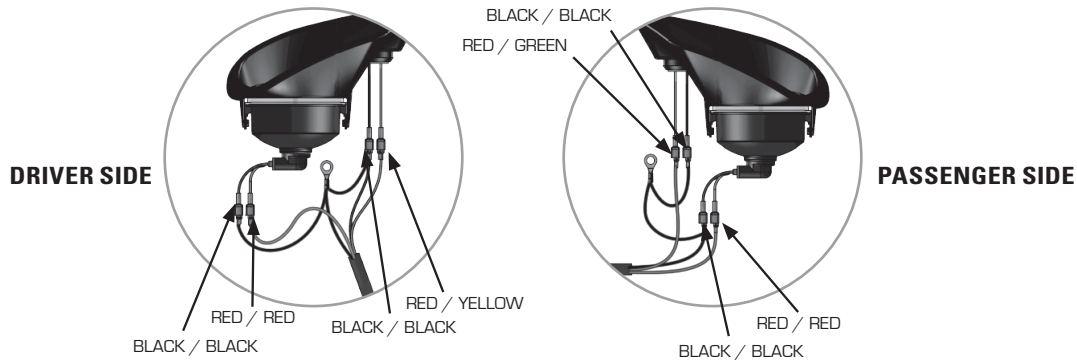

STEP 2.10 TEST LIGHT KIT COMPONENTS - ****WARNING: Do not connect Lights to more than 16v or damage will occur****

IMPORTANT: A Voltage Reducer is recommended to draw power from the full battery bank, which is reduced from 48v or 36v down to 12v for electronics

- If you choose not to use a Voltage Reducer, **DO NOT connect Lights to more**

than 16v (2 batteries) or permanent damage will occur to light kit.

- Connect Light Wiring Harness Negative (-) to Battery #6 Negative (Main -)
- Connect Light Wiring Harness Positive (+) to Battery #5 Positive (+)

After connecting Harness to batteries, proceed to test:

- Headlights • Turn Signals (front & rear) • Tail Lights • Brake Lights • Delayed Brake Light (Park/Shutoff 30-45 sec delay)
- Horn • After successful testing, disconnect Harness from power until final installation.

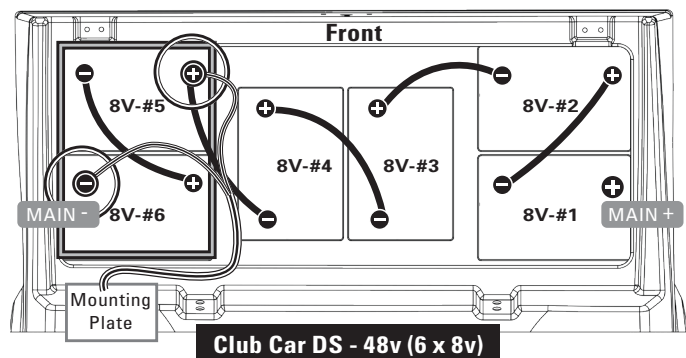
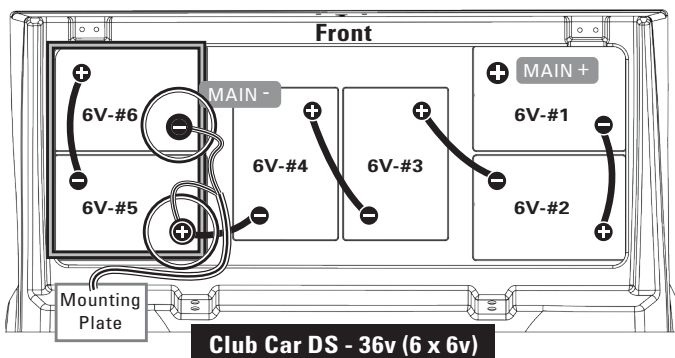

STEP 2.11 INSTALL HEADLIGHTS & GRILLE

- Peel back protective film from the edges of openings in Front Cowl. Reconnect Headlights and install Headlights and Grille using provided Self-tapping Screws.



INSTALL REAR BODY

STEP 3.1 ATTACH REAR SUPPORT FRAME

- Peel back protective film from top edges of Rear Body. Position the Rear Support Frame (1) as shown, and attach Factory Seat Cleats (2) to Body and Support Frame, using **Factory Hardware**.

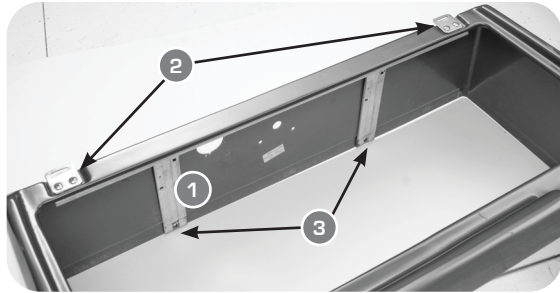

STEP 3.2 POSITION AND MOUNT REAR

- Peel back protective film from the front bottom edge of the Rear Body and the Bagwell floor.
- Set the Rear Body in position and using the Factory Hardware, secure the Body at the bottom front (3 - previous pic) through the Body, Support Frame, and Chassis floor bracket.
- Attach Body to Chassis in the Bagwell floor (4) with **Factory Hardware**.

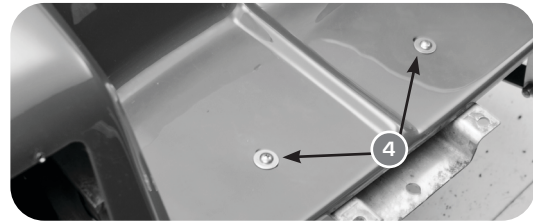

STEP 3.3 INSTALL TAIL LIGHTS & BUMPER

- Peel back protective film where Lights mount. Reconnect Tail Lights and install using Small Self-tapping Screws.
- Reinstall the Bumper using **Factory Hardware**.



STEP 3.4 INSTALL F/R SWITCH

- Peel back protective film and install the Forward/Reverse Switch using the **Factory Hardware**.



STEP 3.5 INSTALL CHARGING PORT

- Peel back protective film and install the Charging Port using the **Factory Hardware**.



HARDWARE - SCALE 1:1

Z x6

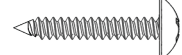

Small Screw

INSTALL OPTIONAL STEERING COLUMN COVER & SENTRY DASH

STEP 4.1 INSTALL THE STEERING COLUMN COVER (OPTIONAL STAINLESS STEEL COVER)

- Reinstall the black plastic Factory Steering Column Cover on the Steering Column by simply sliding it over the Steering Column.

OR, if you have an aluminum Steering Column Cover, install it now:

- (1) Slide Steering Column Cover over the Steering Column so that it is flush with the front edge of the Steering Column. With a Punch, mark a drill-ready hole on the top of the Cover between 1/4" to 1/2" from the top of the Steering Column.
- (2) Drill a 1/8" hole into the Steering Column Cover and Steering Wheel Column.
- (3) Use a #10 Set Screw to secure the Steering Column in place to prevent the Column Cover from rotating.

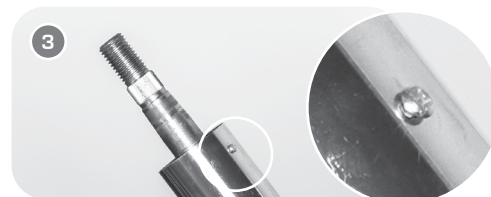

STEP 4.2 MARK AND CUT HOLE FOR TURN SIGNAL WIRING

- ****If you're NOT installing a Turn Signal, then skip this step**** - A 1/2" hole must be cut in the Dash at location (4) to allow the Turn Signal Cable to feed through the Dash where the Turn Signal will attach to the Steering Column.
- Use a quarter or large washer to mark a slightly overlapping circle (4) and cut out circle with a small saw (5). Route the Turn Signal Harness through hole (6).



STEP 4.3 SLIDE DASH OVER STEERING COLUMN AND INSTALL

- Slide the Dash and Turn Signal Harness down over the Steering Column (7).
- Connect Turn Signal Harness to Dash Harness (8) and pull all wiring back into the Dash Center Console.
- Make sure the Sentry Dash is aligned with the Metal Dash Frame and mark hole locations (x6) onto Metal Dash Frame. Using a 9/64" drill bit, drill pilot holes at the marked locations (9). Mount Dash to Frame using Small Screws (Z x 6).
- Determine locations for any switches (Key Switch, Lights On/Off Switch, etc.) on the removeable Faceplate on Dash (10). Cut/drill the required holes and install.

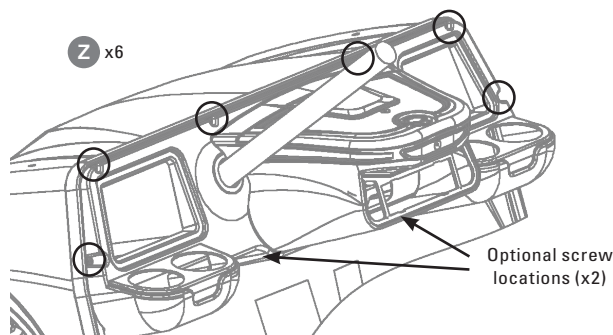
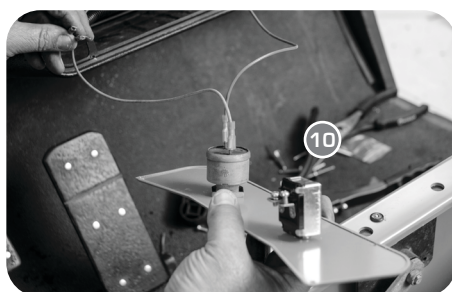
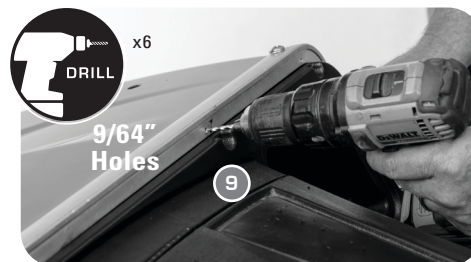
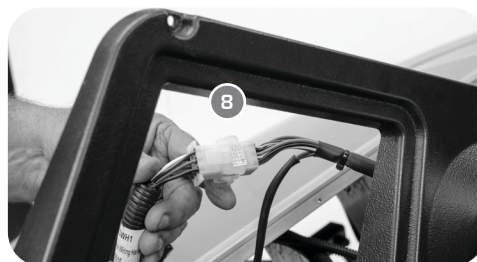

CAT-43: Club Car DS Spartan Body Set & HL - 7

INSTALL OPTIONAL PILOT STEERING WHEEL

STEP 5.1 INSTALL HUB ADAPTER

- Install Steering Wheel Hub Adapter by sliding onto center cog and reinstalling the nut from removed the factory Steering Wheel.

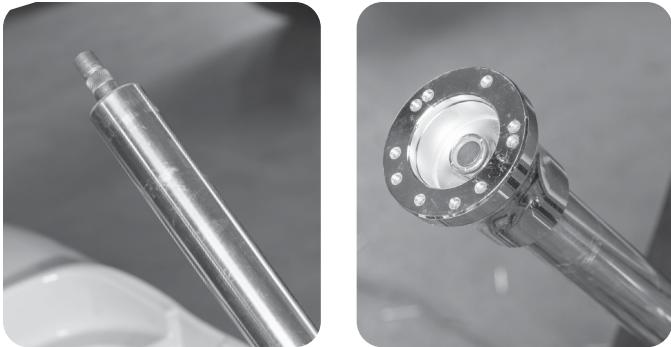

STEP 5.2 INSTALL MAIN ACCENT

- Place Main Accent into Steering Wheel Base. Flip Steering Wheel over and insert screws to secure Main Accent and insert Black Screw Caps.

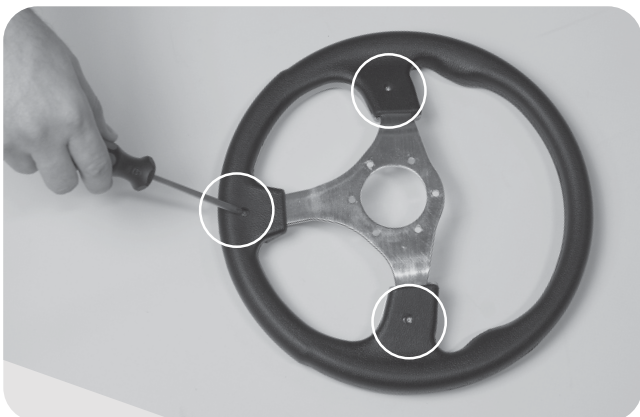
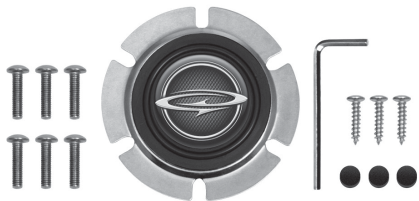

STEP 5.3 INSTALL STEERING WHEEL

- Press the Center Cap Assembly onto the Steering Hub Adapter by aligning the grooves in the Center Cap Assembly with the holes in the Steering Hub Adapter.
- Press the Steering Wheel onto the Center Cap Assembly and check the hole alignment. Using the six hex socket bolts, attach the Center Accent and Steering Wheel to the Steering Hub Adapter. Tighten all bolts in an alternating pattern.

